

PRECISE & SIMPLE

ADAS SOLUTION

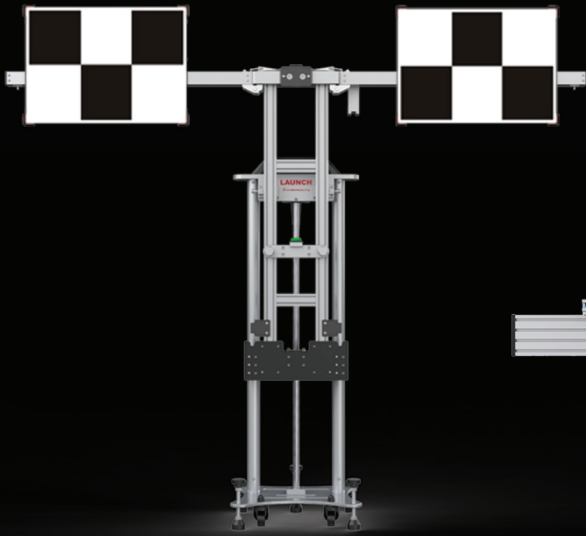

X-431 ADAS MOBILE PLUS

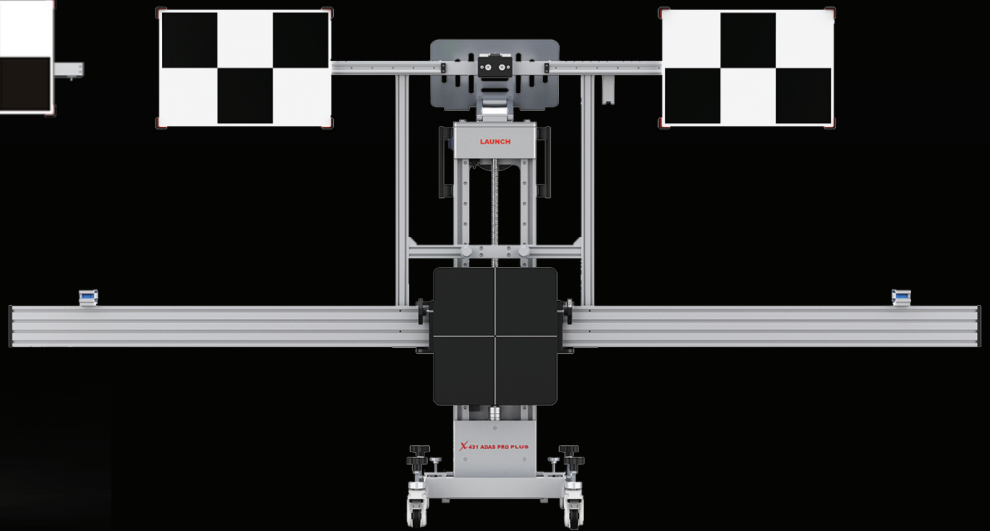

X-431 ADAS PRO PLUS

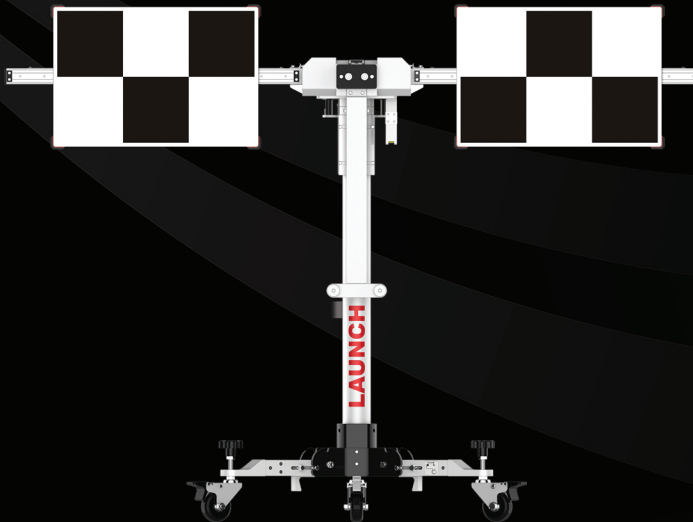

X-431 ADAS MOBILE



X-431 ADAS HD

X-431 ADAS Mobile Plus



Experience mobility and efficiency with the Launch Tech ADAS Mobile Plus. It's the lightest, most portable ADAS solution anywhere.

LDW "Standard" Package (701060005)

Travel-friendly protective case included.

Buy a LDW "Standard" Package and receive a X-431 Turbo III for FREE
 Limited Time promotion, please check with local distributors.



Product	Dimensions	Weight
Turbo III	17" x 5.4" x 14.6"	10lbs
ADAS Mobile Plus	56" x 43" x 28"	335lbs

X-431 ADAS Pro Plus

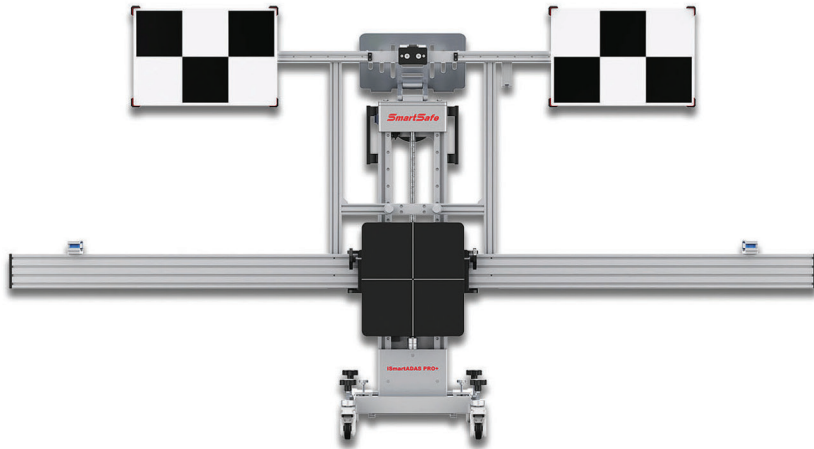

The X-431 ADAS Pro Plus is a precise stationary ADAS system. The wheel clamp based system along with laser measurement accuracy will have calibrations completed in minutes.

LDW "Standard" Package (701040010)

+

X-431 Turbo III

Forward Facing "Deluxe" (701040011)

Everything in LDW Kit and ADAS Accessory Kit +

+

X-431 Torque LINK
(Replace Turbo III)

Premium Package (701040012)

Everything in the top 2 packages kits+ +

+

X-431 ADAS Mobile

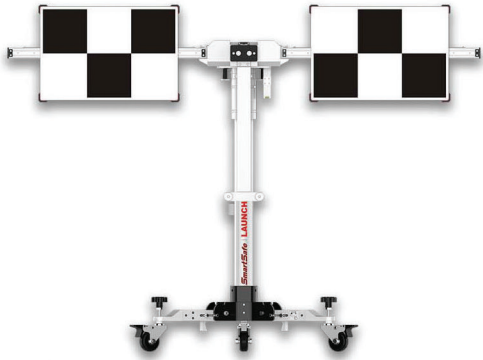

The X-431 ADAS Mobile is designed to be used in your shop or taken on the road. Its easy foldable frame can fit into any vehicle.

LDW "Standard" Package (301250047)

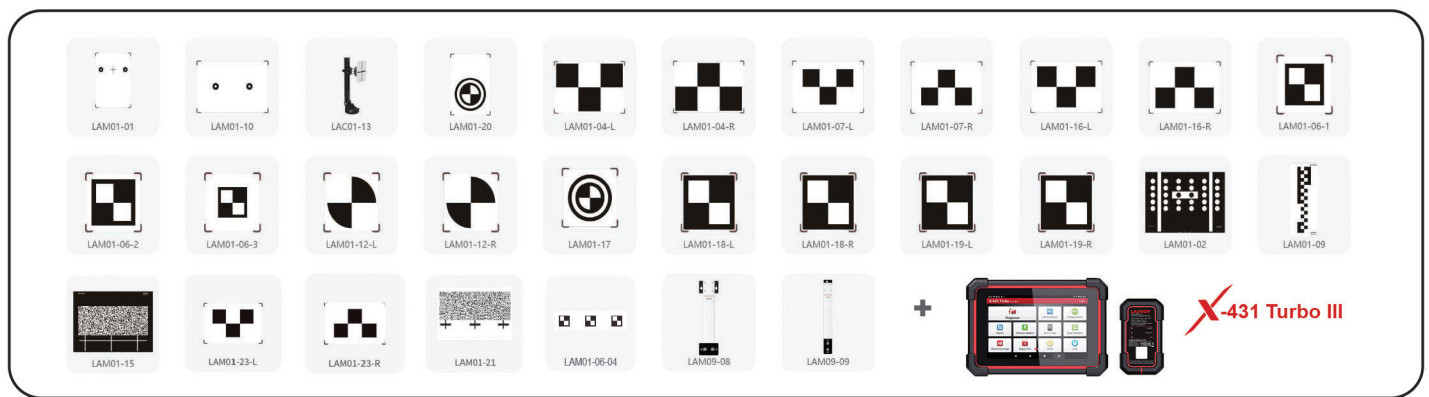

Forward Facing "Deluxe" (701020207)



Premium Package (701020219)

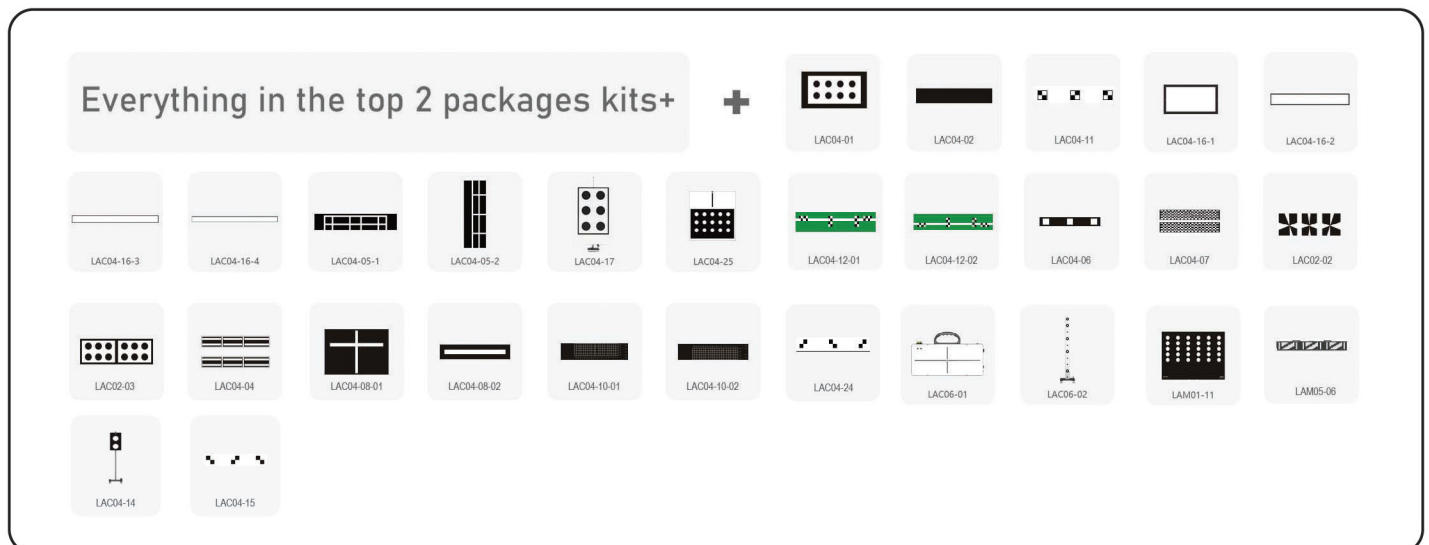

X-431 ADAS HD

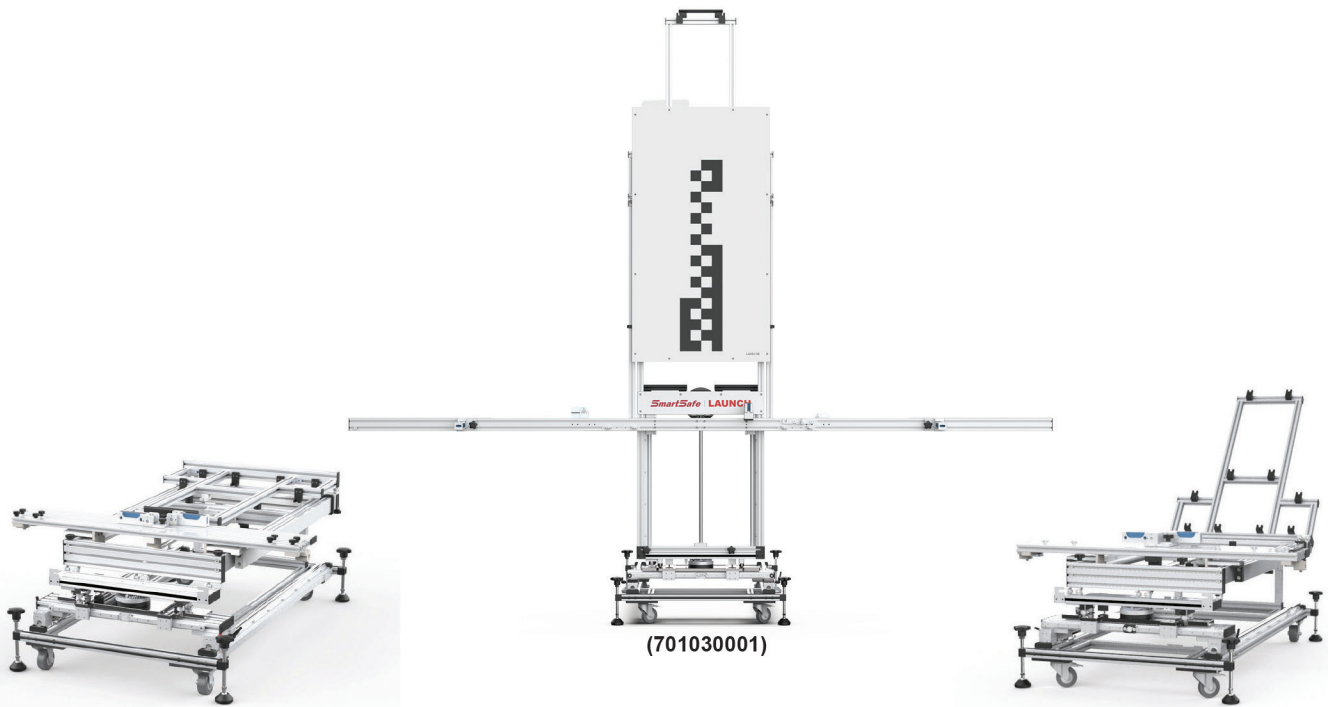

LAH01-08

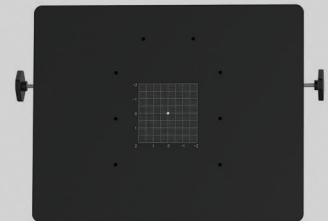

ACC Reflector
LAH05-02

DYNAMIC CALIBRATION

STATIC CALIBRATION

X-431 ADAS Series Compatible Tablets



X-431 Throttle III
(301180833)

X-431 Torque LINK
(321195101)

X-431 Turbo III
(321195201)

X-431 Torque AutoHD Pro
(301190908)

CONFIGURATION

Touch Screen	13.3"/1920x1080 IPS	10.1"/1280*800	8"/1280*800	10.1"/1280*800
Processor	2.0GHz Octa-core	2.0 GHz 4-core	2.0 GHz 4-core	2.0 GHz 4-core
Memory	8GB	4GB	4GB	4GB
Storage	256GB	128GB	64GB	128GB
Camera	Front 8MP, Rear 13MP	Front 5MP, Rear 8MP	Front 5MP, Rear 8MP	Front 5MP, Rear 8MP
Battery	9360mAh @7.6V/71.1Wh	47.88Wh (7.6 V, 6300mAh)	47.88Wh (7.6 V, 6300mAh)	47.88Wh (7.6 V, 6300mAh)
VCI Connection	2.4GHz & 5GHz dual WiFi	Bluetooth	Bluetooth	Bluetooth
VCI Adaptor	Smartlink C	Smartlink C	DBSCARVII	Smartlink C
Adjustable Kickstand	•	•	•	•
Non-16pin Connector Kits	•	•	•	•
IP65 Waterproof & Dustproof	•			
Quick Charge Technology	•			

FEATURES

Vehicle Coverage	1996-Present Passenger cars Medium & Light Duty Vehicles/ Heavy Duty Vehicles (Optional)	1996-Present Passenger cars Medium & Light Duty Vehicles/ Heavy Duty Vehicles (Optional)	1996-Present Passenger cars Medium & Light Duty Vehicles	1996-Present Passenger cars Medium & Light Duty Vehicles/ Heavy Duty Vehicles (Optional)
Operating System	Android™ 9.0	Android™ 10.0	Android™ 10.0	Android™ 10.0
Full System Diagnosis	•	•	•	•
OBD II Full Function	•	•	•	•
Tech 2 Tech Remote Diagnosis	•	•	•	•
Smartlink Remote Diagnosis	•	•		•
Auto VIN Identification	•	•	•	•
Internet Updatable	•	•	•	•
Security Gateway Access	•	•	•	•
Code Assist by IDENTIFIX	•	•	•	•
Register TPMS Sensor ID	•	•	•	•
VW & AUDI Guided Function	•	•		•
CAN FD	•	•	•	•
Dolp	•	•	• *(Need an adaptor)	•
J2534/RP1210/D-PDU	•	•		•

COMPATIBLE MODULES

X-431 ADAS PRO	•	•	•	•
X-431 ADAS Mobile	•	•	•	•
X-431 ADAS HD	•	•		•
X-PROG3 Immobilizer	•	•	•	•
BST360 Battery Tester	•	•	•	•
VSP600 Videoscope	•	•	•	•
HD Add-on Module	•	•		•
O2-1 Scope Box	•	•	•	•
S2-2 Sensor Box	•	•	•	•

ADAS RADAR 3 in 1

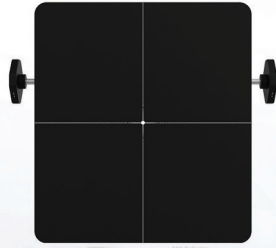

LAM05-02
ACC Radar Target

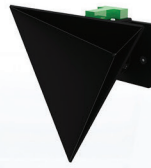

LAC05-03
Corner Reflector



LACO5-04
Doppler Simulator

Accessories



LAR09-01
Mounting adaptor



Five-line
Laser Device



LAM09-03
Laser Reflector



LAM09-04
Auxiliary Mirror



LAM09-05
L-shaped Positioning
Bracket



LAM09-06
Plumb Line



Tape-10m



Main Unit



Travel-friendly Protective Case

Description	ERP Code
Radar 3 in 1(ACC+Doppler+Corner Reflector) Set without Bags	701070002
Radar 3 in 1(ACC+Doppler+Corner Reflector) Set with Bags	701070015
Bag for Radar 3 in 1(ACC+Accessories)	701070013
Bag for Radar 3 in 1(Main Frame+Doppler+Corner Reflector)	701070014

Target



LAM05-02
ACC Radar Target



LAC05-03
Corner Reflector



LACO5-04
Doppler Simulator

Calibration System

ACC (Adaptive Cruise Control)

ACC (Adaptive Cruise Control)
BSM (Blind Spot Monitoring)

LCA (Lane Change Assist)
FCR (Front Corner Radar)

Vehicle Coverage

Mercedes-Benz, BMW, Audi, Volkswagen, Porsche, SKODA, Seat, Romeo, MINI, Bentley, Rolls-Royce, Maserati, FIAT, Jeep, Nissan, Mitsubishi, Suzuki, Infiniti, Hyundai, Kia, BYD, GEELY, CHERY, etc.

Toyota, Lexus, Honda, Acura
Mazda, Subaru, Mitsubishi, etc.

Volkswagen, Audi, SKODA, Seat, Mazda, etc.

Additional Products

Optional Targets (All Panels are Universal)

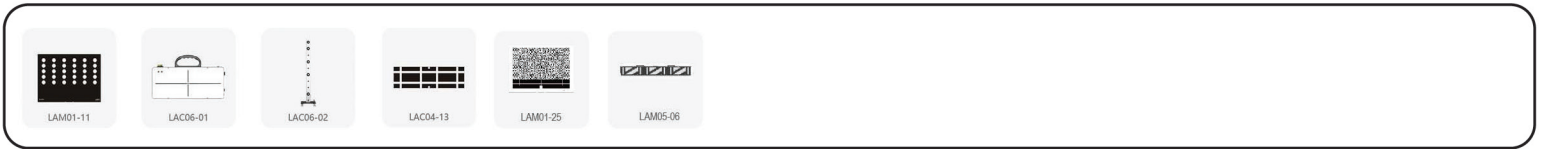

Radar Alignment Tool (701020174)



Roxie W (301050450)



TIT-202 Pro (307020098)



ADAS Mobile Cart (Black) (307041605)



New Targets

Europe

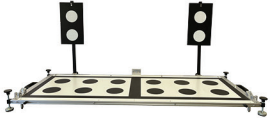

LAC02-03 & LAC04-14

Other

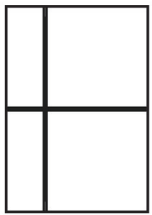

LAC04-28

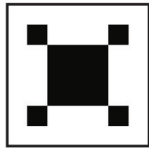

LAC04-29-1

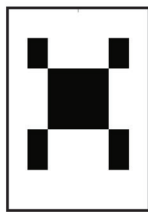

LAC04-29-2

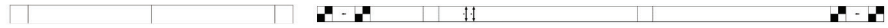

LAC04-31-1

LAC04-31-2



LAC04-31-3

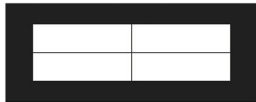

LAC06-03 (A)

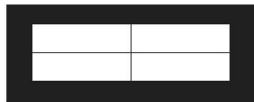

LAC06-03 (B)



LAC03-01



LAC07-01



LAC07-02



LAC07-03



LAC07-04-01



LAC07-04-02

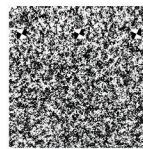

LAM01-29

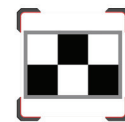

LAM01-30-L



LAM01-30-R



LAM01-31

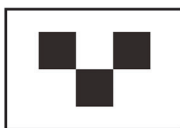

LAM01-32-L

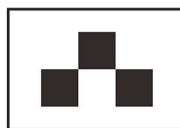

LAM01-32-R



LAC05-05

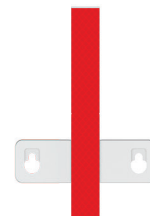

LAC05-07

Forward Facing ADAS Space Requirement

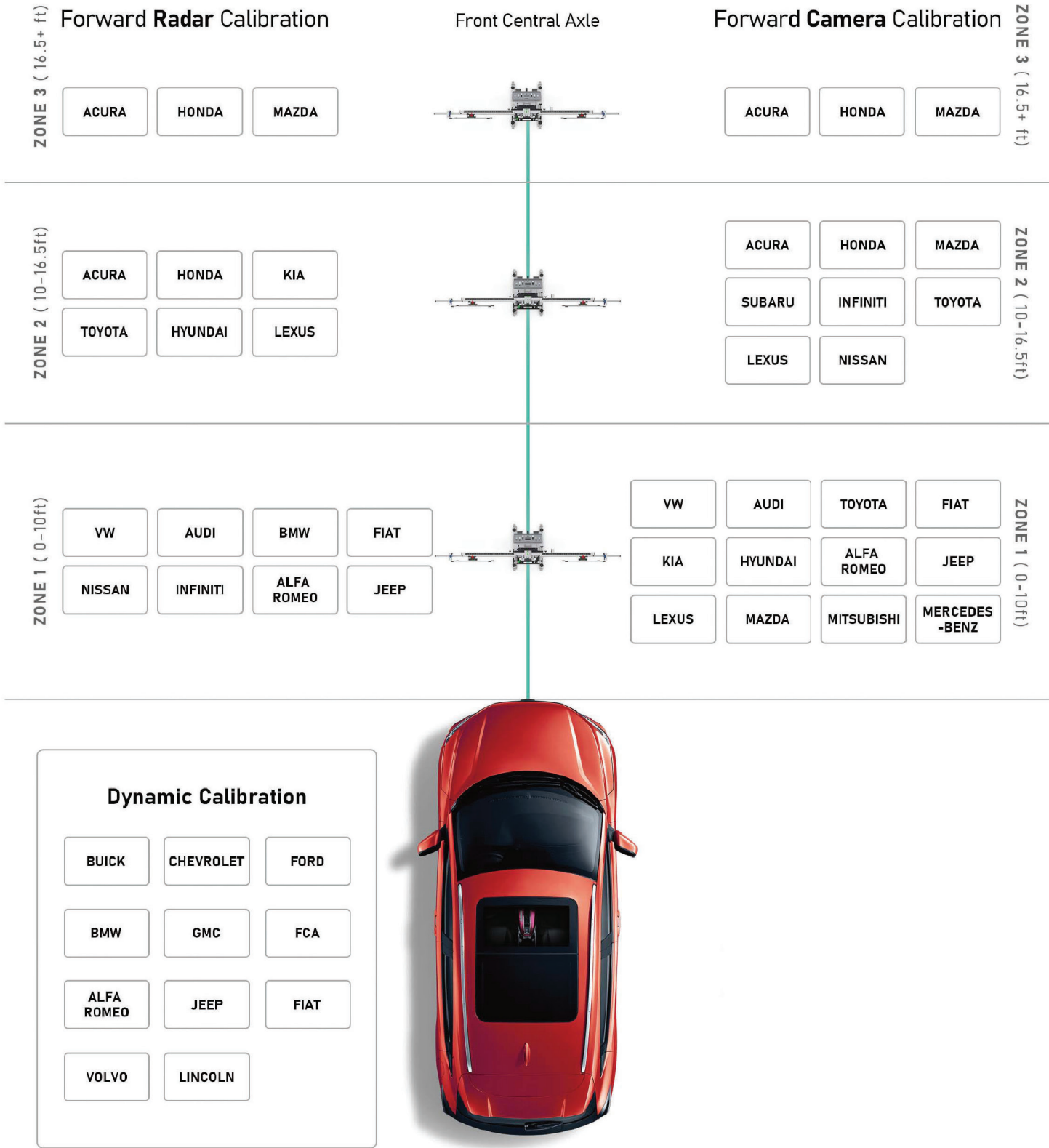

This is the required space to place ADAS calibration targets. Space requirement as the vehicle or other equipments should be considered in accordance with specific conditions.

LAUNCH TECH USA

CREATE • CHANGE

*Scan to View
Our Products Online*



LAUNCH TECH USA

CREATE • CHANGE

The final interpretation right of this document belongs to LAUNCH TECH USA, INC.

Follow Us



1-877-528-6249



www.launchtechusa.com



sales@launchtechusa.com